

FRONT PAGE

PROJECT FINAL REPORT

Grant Agreement number: 289194
Project acronym: BIOCONSEPT
Project title: "Integration of Bio-Conversion and Separation Technology for the production and application of platform chemicals from 2nd generation biomass"
Funding Scheme: FP7-CP-TP
Period covered: from January 1st 2012 to December 31st 2015

Name of the scientific representative of the project's co-ordinator¹, Title and Organisation:
Dirk Verdoes, Netherlands Organisation for Applied Scientific Research (TNO)

Tel: +31 888 66 6371
Fax:
E-mail: bioconsept@tno.nl;
Project website address: www.bioconsept.eu

¹ Usually the contact person of the coordinator as specified in Art. 8.1. of the Grant Agreement.

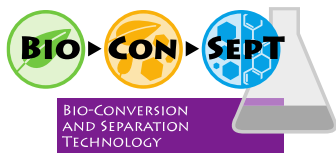

Contents

<i>FRONT PAGE</i>	1
1. Publishable summary	3
1.1. Executive summary	3
1.2. Project context and Objectives	4
1.3. Main scientific and technological results	7
1.3.1. 2 nd generation feedstocks and processes	9
1.3.2. The production of platform chemicals from lignocellulose	10
1.3.3. Production of platform chemicals from non-edible oils & fats.....	16
1.3.4. In-situ product removal (ISPR).....	20
1.3.5. Demonstration of 2 processes on pilot scale	23
1.4. Potential impact	25
1.4.1. Potential impact and societal implications	26
1.4.2. Main dissemination activities and exploitation	31
1.5. Website and contact details	32
1.5.1. Project website	32
1.5.2. Contact details	33

1. Publishable summary

1.1. Executive summary

BioConSepT, a 4-year flagship demonstration project with 30 partners in the EU FP-7-KBBE programme, focused on demonstration of the technical and economic viability of bio-based value chains which started with 2nd generation feedstocks and ended with semi-/ or end-products like polymers, plasticizers, resins, solvents, and surfactants. Each of the value chains contained 4-6 steps and required intensive co-operation between the partners. The products were derived from 6 platform chemicals/building blocks: itaconic acid (IA), succinic acid (SA), 2,5-furandicarboxylic acid (FDCA), Long-Chain Dicarboxylic Acids (LC-DCA), amines/amides and epoxides and 2 side streams: bio-surfactants and Glycerol Carbonate (GC). The 2nd generation feedstocks originated from lignocellulose (wood, agricultural residues) or non-edible oils & fats and were not in competition with the food chain, had sufficient availability, and foreseen to create an impact at the European level.

At the end of the lab-scale R&D after 3 years, the IA-, SA-, FDCA-, epoxides- and bio-surfactants value chains were considered to be technically ready to go to the demonstration in year 4. The results for LC-DCA were also good, but they were obtained with a BSL-2 organism. It was decided to continue lab-scale R&D on LC-DCA in year 4 to develop a BSL-1 organism in view of the industrial interest in LC-DCA. The results for amines/amides and GC were insufficient to consider demonstration. The effects of the 2nd generation feedstocks were ambiguous: below the 1st generation reference for IA and FDCA and comparable to 1st generation for SA, epoxides, LC-DCA, and bio-surfactants. It is recommended to continue R&D on 2nd generation feedstocks in future programmes with a focus on decreasing costs and diminishing negative effects caused by impurities that are often present in the 2nd generation feedstocks.

FDCA and epoxides were chosen for the demonstrations. Both value chains were piloted in an industrial environment and at a relevant scale, resulting in the delivery of 50 kg of FDCA and 500 L of epoxides for application tests in polymers and plasticizers. All steps from the feedstock to the end-product could be executed, but sometimes small adaptations of the lab scale protocols were made to fit the process in the equipment available at the demo sites. The demonstrations generated valuable ideas for further improvement and scale up of the processes. For FDCA, significant progress has been made in the production of HMF and the downstream purification. The main points of attention are the costs and origin of the fructose and the bioconversion from HMF to FDCA in BioConSepT, which was below the state of the art despite that HMF impure process waters were used in the project. A plant design based on BioConSepT results revealed that the costs for FDCA would still be too high for large-scale, drop-in applications, but smaller, high(er) added value applications seemed to become in reach. However, the FDCA process price was reduced from 10 euro/kg to 3,5 euro/kg during the project time frame with the project process developments. A major achievement in the epoxide demo was that a waste oil was converted with good yield into a valuable product with excellent properties. The plant design revealed that the sustainability profile of the process is competitive and the process can be economically profitable provided that the costs for the enzymes can be kept low enough by lowering the costs of the enzymes and/or improving their recyclability.

Sharing results outside the consortium was important for BioConSepT as can be illustrated with the Course on In-Situ Product Recovery in Antwerp, the launch of the Bio-Based Serious Game in Brussels and the open, final event in Leuna where 60 participants visited the demo site of Fraunhofer CBP and listened to 20 pitches BioConSepT such as bringing the IA value chain to demonstration in Bio-QED (www.bioqed.eu), the development of fungal production hosts for the production of organic acids from 1st and 2nd generation

feedstocks in the spin-out company Dutch DNA and scale up of the HMF production for use in FDCA and PEF by AVA-Biochem.

1.2. Project context and Objectives

The consortium behind the BioConSepT project, with the full title: “Integration of **Bio-Conversion** and **Separation Technology** for the production and application of platform chemicals from 2nd generation biomass”, wanted to convince and inspire companies and stakeholders by demonstrating the complete feasibility of an integrated chain approach which is regarded as the basis for the next generation industrial White Biotech processes.

For the EU the **biotechnological production of fuels and chemicals from renewable biomass** often referred to as **White Biotechnology**, is a real opportunity as important criteria for establishing a leading position on a global scale are very positive for the EU. For instance, the EU has well-developed chemical and agro-food industries, the scientific position of the EU on industrial biotechnology is excellent and the EU has the logistic infrastructure needed for the envisaged transition. Strategic documents like The Knowledge Based Bio-Economy (2010, Albrecht), the Lead Market Initiative (2007, European parliament) and Key Enabling Technologies (2009, European parliament) all show the importance and opportunities offered by the transition from a fossil-based to a Bio-Based Economy. The importance is amongst others reflected by extensive KBBE R&D program under FP7 which was followed by the erection of the Public -Private Partnership on Bio-Based Industries (BBI) under Horizon 2020.

In order to **establish the desired leading position**, it is essential that ideas with the status of a successful proof-of-principle and technically feasible are further improved and integrated in order to execute an **industrially relevant demonstration**. Developments in BioConSepT were focused on abundantly available so-called 2nd generation feedstocks like wood and agro-food residues such as straw and stover, which in contrast to 1st generation feedstocks like glucose and starch, are **not in competition with the food chain**. **Sufficient market volumes** and **potential applications** are needed to create an impact on the economics, the environment and the society of the EU. The BioConSepT consortium is convinced that there is not a lack of good ideas on 2nd generation white biotech processes, but that too few of them are brought into practice. In other words, BioConSepT wanted to guide the 2nd generation white biotech processes across the famous “Innovation Valley of Death”.

BioConSepT aimed at demonstration of the technical feasibility of white biotech processes that convert 2nd **generation biomass feedstocks** like lignocellulose and non-edible oils & fats into valuable **platform chemicals** like di-carboxylic acids, amines and epoxides. Platform chemicals are versatile chemical intermediates, which can be converted into multiple end-products and which can be used in various applications such as polymers, resins, additives, solvents and surfactants. The overall target was to develop technology to produce **bi-functional platform chemicals**, which are **30% cheaper** and **30% more sustainable** than the corresponding conventional chemical routes.

The following main objectives were defined, such as to support the realization of this ambitious goal of the project:

- Utilization and valorization of renewable biomass which is not in competition with the food chain in an effective way

- Development and application of robust enzymes and micro-organisms suited for conversions based on 2nd generation feedstocks. In addition, smart combinations of bio- and chemical conversions were investigated in order to facilitate the integration in existing chemical production chains.
- Integration of bio-conversion with highly selective separation technologies;
- Demonstration of 2 biotechnology processes for platform chemicals from 2nd generation biomass at industrial relevant scale
- Investigating of the whole chain from abundantly available 2nd generation feedstocks up to the intermediate and end-products that can be made from the selected platform chemicals;

To be more specific, research in BioConSepT was targeting for developments on the following platform chemicals: **Furan-Di-Carboxylic Acid (FDCA)**, **Itaconic Acid (IA)** and **Succinic Acid (SA)**, which were all derived from lignocellulosic biomass and **Long Chain Di-Carboxylic Acid (LC-DCA)**, **Amines** and **Epoxides** which were based on non-edible oils & fats as feedstocks. The non-edible oils & fats platform also evaluated the valorisation of the by-products **glycerol carbonate** and **bio-surfactants**.

The technical work of BioConSepT was organised in the following five Key Research Areas, which together formed the scope of the BioConSepT project:

- 2nd generation feedstock;
- Robust micro-organisms and enzymes;
- Bio- or chemical conversion plus (integrated) separation & purification;
- Demonstration at industrial relevant scale; and
- Applications.

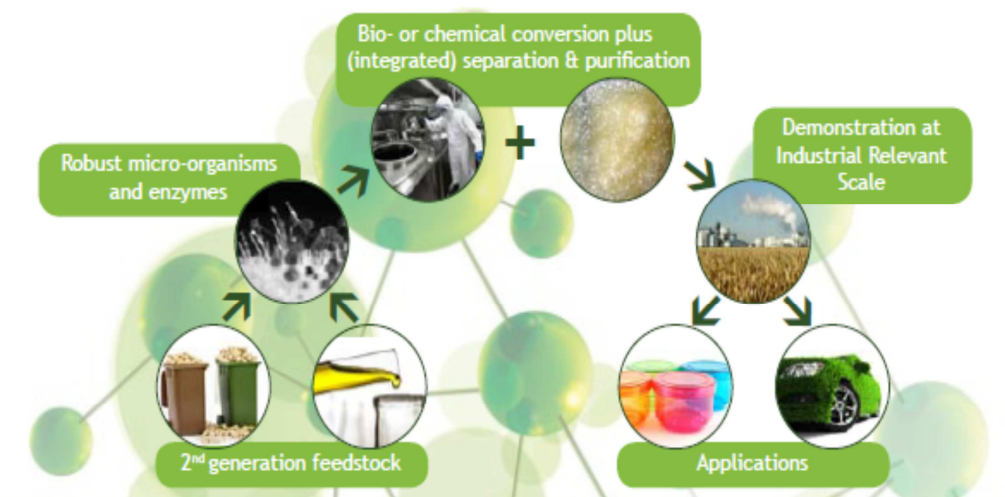

Figure 1: The Key Research Areas in BioConSepT plotted in an artist impression of a White Biotechnology production chain from feedstock to product

Major achievements have been accomplished in the different areas and process chains addressed in BioConSepT. Crucial for the success obtained in the project value chains was the introduction of chain coordination at the end of the first period. This initiated an intense cooperation and problem solving between all partners in a value chain over the borders of work packages. Value chain coordination has created insight in how different areas of expertise and partners could help each other, it stimulated partners working together on one location and has contributed to the preparation and execution of the successful pilot demonstrations.

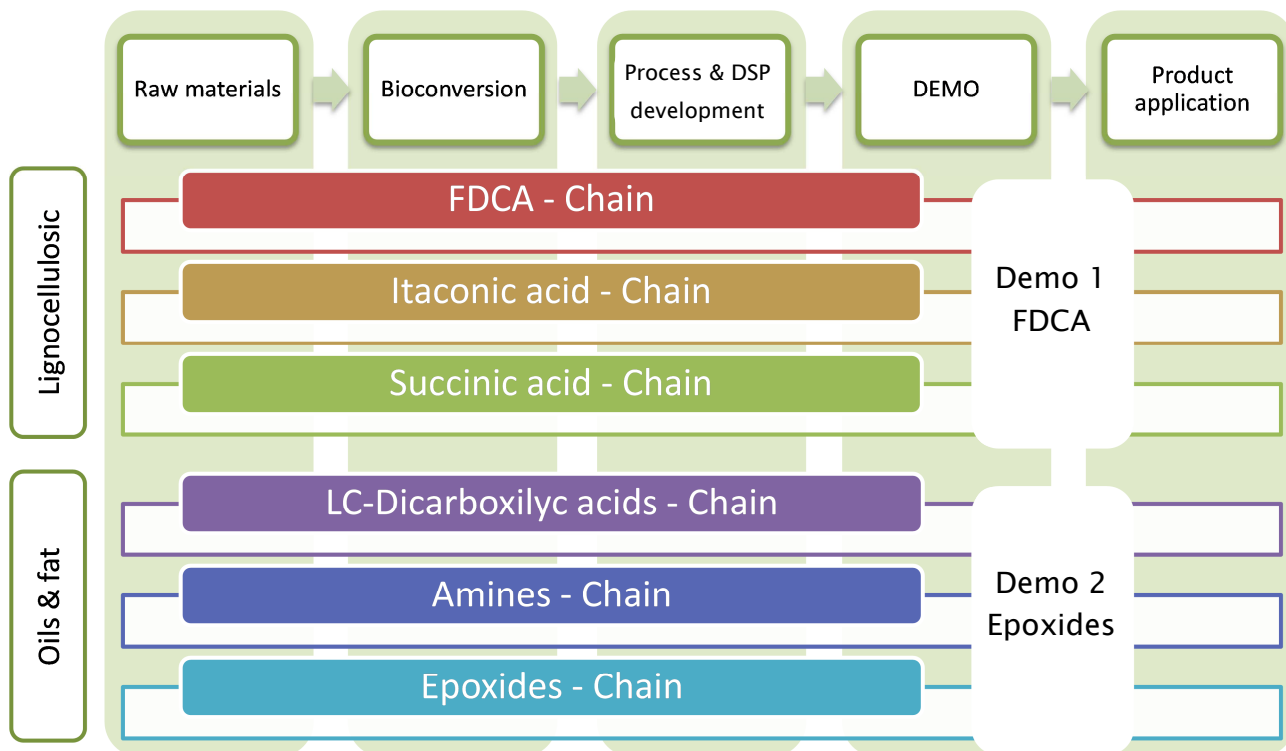

Figure 2: Schematic presentation of the chain coordination and interaction among work packages of platform chemical chains selected for BioConSepT

The next section presents an overview of the main results achieved in the Key Research Areas.

The first Key Research Area was “2nd generation feedstock”. This area covers all activities related to feedstock, meaning both supply and pre-treatment. In the initial phase all information on composition, availability and prices were collected for both the lignocellulosic as well as for the non-edible oil & fats feedstocks in order to provide the necessary input for process development. Pilot plants for the pre-treatment, fractionation, and purification of 2nd generation feedstocks were put in operation and partners were supplied with feedstocks required for their research.

The second research area, “Robust micro-organisms and enzymes”, focused on the development of various (bio)-conversions, which could be microbial, enzymatic or chemical. The work focused on the development of conversions that can be operated reliably and efficiently despite of the presence of the typical impurities related to 2nd generation feedstocks. Microbial and/or enzymatic conversions were investigated for the production of the platform chemicals Itaconic Acid, Succinic Acid, FDCA, LC-DCA, epoxides and biosurfactants. Chemical conversions have been explored for the production of HMF (the precursor of FDCA), diamines and glycerol carbonate.

The third Key Research Area focused on the integration of (bio-) conversion and separation processes in order to improve yield, efficiency, and sustainability. Feasible (bio)-conversion, separation and purification processes have been tested in bench scale equipment using 1st and 2nd generation feedstocks as substrate to produce itaconic acid, succinic acid, FDCA, LC DCA, epoxides and bio-surfactants. Various proof of principles for the technical feasibility have been obtained at bench scale and for FDCA and epoxides the selected conversion, separation and purification processes were scaled up to demonstration. BioConSepT has created a toolbox of (in-situ) separation and purification processes that can not only be applied for the platform

chemicals investigated in BioConSepT, but that can also be applied to other bio-based molecules. The molecular properties and the process conditions determine which separation and purification techniques can be used and the public deliverable "Technology roadmap for the purification of platform chemicals and side-products" reported promising combinations of conversion and separation and/or purification steps, to harvest the target platform chemicals directly from the fermenter. In addition, BioConSepT has organized a 2-day public workshop on In Situ- Separation and Purification to present the state-of-the-art of this important field to scientists from inside and outside the consortium.

Early in the project the preparation for the two demonstrations, which form the core of the fourth Key Research Area "Demonstration at industrial relevant scale", was started by making basic Conceptual Process Designs (CPDs) for each of the platform chemicals. The CPDs were used in the first round of techno-economic modelling and for a preliminary assessment of the sustainability of the value chains. The output from the CPDs was used to focus the further optimization of the individual steps and the integrated chains. At the end of the research phase, FDCA and epoxides were selected as the chains for the two industrial relevant demonstrations. The demonstrations have been executed on the premises of the Fraunhofer Center for Chemical-Biotechnological Processes in Leuna, the pilot facilities of VTT in Finland and pilot facilities of Proviron in Belgium.

The work in the fifth Key Research Area "Applications" focused on setting quality and quantity requirements for applications of the platform chemicals in polymers, plasticizers, solvents and bio-surfactants. The research was started with commercially available samples, but later on the application development was done with samples of the platform generated in the lab and demo scale experiments. Itaconic acid, FDCA and LC-DCA were tried out in polymer applications, Succinic Acid, FDCA, epoxides and LC-DCA were explored for their potential use in bio-based plasticizers and it was tried to develop green solvents based on amines and deep eutectic solvents originating from mixtures of bio-based molecules. The bio-surfactants were tested on their potential use in cleaning and cosmetic applications. An important learning from the project was the synergy and direction that arose as a result of the simultaneous development of the production processes and the applications. In summary, BioConSepT has generated promising and interesting applications in a variety of applications/products. Some of the application leads will be continued after the end of the project.

Dissemination strategy was done on the development of a demo version of the Serious Bio- Economy Game, an In-situ product removal external course, final exploitation event among different participations in seminars and conference in and outside Europe. The standard dissemination activities like IP management, dissemination of Deliverables and support in events were also contributing to these activities.

1.3. Main scientific and technological results

General overview

BioConSepT has developed and delivered 8 different processes to produce biobased building blocks from lignocellulosic and oil & fats feedstocks (see Figure 2). All of these processes have been developed from concept to lab scale and the research & development have been focusing on strain and fermentation development, process design and evaluation, and optimization of the different studied processes and concepts by applying ISPR.

In the case of development of the processes and building blocks from 2nd generation feedstocks (Itaconic acid, FDCA, and succinic acid), the main developments were done in the improvement of the robustness of the used strains and fermentation protocols to deal with the impurities that these materials normally bring. This was also affecting the efficiency of the recovery and purification techniques. However, after a detailed evaluation of different process techniques (membrane, crystallization, electrodialysis, extraction, adsorption among others) a feasible process for each of the evaluated molecules was created and tested. In the case of itaconic acid, a process where integration of fermentation and product recovery by freeze crystallization was achieved and tested up to bench scale. The feasibility study done for this process showed a high potential for commercial implementation of the developed process and, therefore, it was decided to further evaluate this process at an industrially relevant environment in a new project (BioQED). For succinic acid, no big achievements were obtained in the fermentation process compared to the current state of the art. However, the DSP and processing techniques investigated to recover and purify this molecule (extraction and absorption), might bring new process perspectives that could be more competitive than the current implemented industrial ones. Finally, a novel and feasible process was developed and tested at pilot scale for the production of FDCA. The process created here brought the initial FDCA production cost almost 70% lower by developing FDCA fermentations using impure HMF process waters and novel crystallization technologies to purify this molecule.

Non-edible oils were the second renewable resource for the production of bi- or multifunctional molecules within BioConSepT. When selecting suitable 2nd generation oils & fats abundant feedstock availability was ensured by involving industrial partners. The targeted development of production processes for selected platform chemicals was based on sufficient market volumes and potential applications of the products, to be in position to create an impact on the economy, environment, and society in the EU. To do so, the BioConSepT consortium selected plant oil-based epoxides, long-chain dicarboxylic acids (LC DCA) and long-chain amines as the targeted platform molecules for which biotechnological or chemical processes need to be developed or optimized. In addition, biosurfactants and glycerol carbonate were considered to facilitate an integrated utilization of the feedstock and, therefore, adding value to the oils & fats chain. The enzymatic epoxidation process was optimized using an immobilized lipase as biocatalyst and scaled-up to 100-L scale with integrated enzyme-reuse using non edible oils & fats from Proviron. The epoxides were used for the production of plasticizers, e.g. for application in PVC. Long-chain dicarboxylic acids were produced by microbial fermentation. As substrate, long-chain alkanes or alkenes, fatty acids and derivatives thereof can be converted into long-chain DCA using different yeast strains. Different strain modifications were carried out, and the fermentation process with different feedstock (C9-C22 chain length) was investigated and optimized. The dicarboxylic acids were tested for polymer applications. Furthermore, the chemical conversion of dicarboxylic acids into diamines was proven for sebacic acid as a biobased long-chain bifunctional model compound. Biosurfactants Mannosylerythritol lipids (MEL), Cellobiose lipids (CL) and Sophorolipids (SL) from 2nd generation sugar and oil substrates were produced up to 30-L-scale. These biosurfactants were tested in formulations and applications in cosmetics. In addition glycerol, a side stream of fatty acid production was converted in a carbonation process to the bi-functional glycerol carbonate molecule.

For the process development of the lignocellulose and non-edible oils chains, different ISPR technologies were studied and evaluated. In here, different approaches on the integration of conversion and separations supported by developments of novel reactor concepts were investigated, designed and tested at lab and

bench scale. BioConSepT consortium believes that these technologies have a big potential to improve current industrial processes and in some cases has decided to take the concept evaluated here to other projects where the technologies will be evaluated at relevant industrial scale (e.g. itaconic acid in BioQED).

Finally, the building block product samples obtained during the evaluation of the processes shortly introduced above were used for further application tests in production of polymers, polyesters, and plasticisers. These applications not only gave results where it was proven that the materials are suitable for these applications but also gave feedback to the process development work by pointing out the requirements and standard needed for a successful application.

An overview of the main results obtained in BioConSepT for the different platform chemicals and technologies used is given in the following sections.

1.3.1. 2nd generation feedstocks and processes

2nd generation feedstocks were provided to the consortium partners to carry out development on fermentation processes and recovery of products using these materials. At the start of the project small samples of feedstock were distributed to the BioConSepT partners for characterization and evaluation. See Figure 3 for a picture of a set of feedstock samples shared with a special guest at the Leuna facility of Fraunhofer. Also larger quantities of feedstock have been shared with the BioConSepT partners for bench and pilot scale test.



Figure 3: Small volumes of feedstock have been shared with Germany's chancellor Ms. Merkel during the opening of the pilot facility of the Fraunhofer CBP institute in Leuna.

Different feedstocks, i.e. beech wood, sugar beet, wheat straw, vegetable oils, and HMF process waters were distributed to the BioConSepT partners for strain and bioconversion development. During the last year of the project, pilot tests were performed requiring feedstock supplies. There, large quantities of HMF process waters and vegetable oils, were distributed to the chosen value chains for further piloting work.

The following biomass pre-treatment technologies were evaluated within the project: organosolv and acetosolv for the lignocellulosic material, and chemical conversion of oils and fats into fatty acids In the case

of organosolv and acetosolv, the comparison between these two conversion processes showed that both technologies were suitable to supply feedstock for further processing in the project. The product costs were strongly related to the feedstock costs; in terms of process costs there was no significant difference which is reflected in the techno-economic evaluations. However, the evaluated technologies were not used during the pilot tests carried out at the end of the project due to the fact that the value chain chosen (FDCA) for scale up needed its feedstock from HMF production. For the oils and fats conversion, the chemical routes evaluated gave good results on the production of long chain dicarboxylic acids and epoxides. One of the evaluated conversions, Epoxides was further developed and piloted. This process is further explained in section 1.3.3. Finally, large quantities of HMF process waters were sent to project partners to produce FDCA at bench and pilot scale. These HMF process waters are considered for the project as a second generation feedstock due to the large quantities of impurities and their low cost compared to pure HMF.

1.3.2. The production of platform chemicals from lignocellulose

From existing Biorefinery projects cellulose and hemicelluloses were provided within the project for the production of Itaconic and succinic acid, where C5-C6 sugars were the basis for fermentation of these compounds. The conversion and processes developed to produce and purify these molecules will be presented in this section. Additionally, impure HMF process waters were used to produce FDCA (biotransformation). The platform molecules FDCA, itaconic acid and succinic acid were further tested for the end-consumer products; polymers, resins and additives.

2,3-Furandicarboxylic acid (FDCA)

FDCA is a bio-based building block for resins and polymer appointed as a green replacement for terephthalate as well as a base chemical. The potential market size has been estimated at US\$ 4-12-billion. Diverse approaches for the chemo-catalytic oxidation of 5-hydroxymethylfurfural (HMF) or 2,5-diformylfuran (DFF) to FDCA have been developed as well as the conversion of sugars into HMF, where Biochemize has demonstrated that a metabolic pathway (unknown until now) exists in some fungal species, and could be used at industrial level in future. To date, a whole cell biocatalytic FDCA production process has been developed². This process employs the solvent tolerant bacterium *Pseudomonas putida* S12, expressing a specific oxidase from an inhibitor-tolerant bacterium *Cupriavidus basilensis* HMF14 that is capable of oxidizing HMF to FDCA². However, this strain and similar ones have not been tested with 2nd generation feedstocks.

Within BioConSepT, the aim was to develop the biological conversion of HMF to FDCA at low and neutral pH values to reach a more sustainable process. The fermentation optimization was done by **Fraunhofer** and **VTT**. The results obtained in the conversion part showed that it was extremely challenging to convert HMF into FDCA at low pH values using a biological route. Nevertheless, the bioconversion of HMF into FDCA at neutral pH values evaluated at lab scale using a modified *Pseudomonas putida* strain showed high conversions up to 10 L scale. At lab scale, all HMF process water batches provided by AVA Biochem were usually first tested in 1-liter scale and then at 10-liter scale. Different feeding rates of HMF-containing process waters and the toxicity to the strain were tested in 1-liter scale fermenters. Results showed that the more concentrated the process waters were, the more toxic were they for the microorganism, and

² Koopman, F., Wierckx, N., et al., *Bioresource Technology*, 2010, **101** (16): p. 6291-6296.

optimization of the feeding rate was crucial in achieving a high conversion. After feeding and protocol optimization, the best results obtained at lab scale showed a conversion of 90%wt of HMF into FDCA. Fermentation profiles of this experiment are presented in the following figure.

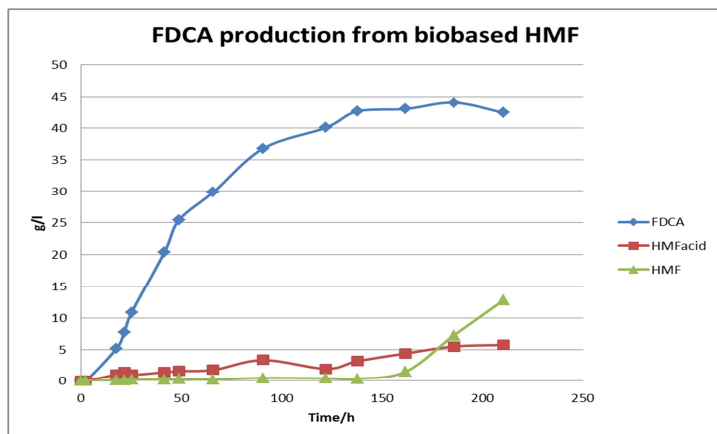

Figure 4: Production of FDCA (volume 10 L) from HMF process water provided for pilot scale cultivations

TNO developed in lab scale the downstream processing to recover and purify FDCA. From the options evaluated for FDCA recovery from fermentation, precipitation by acidification with sulfuric acid showed the most suitable option to recover the most of the FDCA out of the fermentation broth and also was the simplest to scale up (see further information in public deliverable 5.2). This technology was tested at lab scale and tested at 10 L scale to polish the protocols for further scale up. Lab and bench scale evaluation of precipitation by acidification showed that to be able to recover FDCA as a fully undissociated acid the broth should be of acidity below pH 0.8. Furthermore, to purify FDCA, re-crystallization from solvent was selected as the best technology to get pure FDCA crystals. To select the best solvent to test re-crystallization as the purification technique, the solubility of FDCA in selected solvents, chosen by crystallization experts, was evaluated. The following solvents were chosen to be tested in FDCA re-crystallization: DMSO, DMP, and methanol. Additionally, re-crystallization from super heat water was considered and the protocol was implemented based on data from literature.

After the evaluation of these solvents, samples were analysed to determine the FDCA purity reached with these purification methods, and also evaluated by **Evonik** as starting material for esterification (one of the studied applications of FDCA). All samples were produced with FDCA made by *P. putida* fermentation, which was fermented with HMF process waters. From the application tests, it was selected by **TNO** and **AVA-Biochem** experts that the best method to purify FDCA was re-crystallization in super heat water. The following Figure shows the samples of FDCA obtained after purification with this method. Purities of 99.9 %wt were reached by this technology at 1 L scale. The major challenge to scale up this technology is to heat up the FDCA water solution to 180 °C and cool it down in less than 20 minutes. This is due to the fact that when this residence time is exceeded, the risk of cooking the FDCA is quite high and then the product will be wasted. With this remark, protocols of the lab scale test were transferred from **TNO** to **Fraunhofer CBP**. Several discussions were taking place between the two parties to find the best approach for the scalability of this technology.

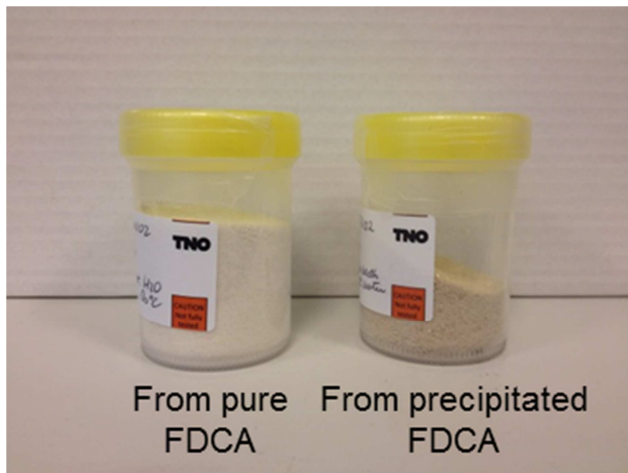

Figure 5: FDCA samples obtained after purification of FDCA by super heat re-crystallization at lab scale.

After validating different recovery and purification technologies at lab scale, the following process (Figure 6) were designed and evaluated as potential candidates for test at pilot scale:

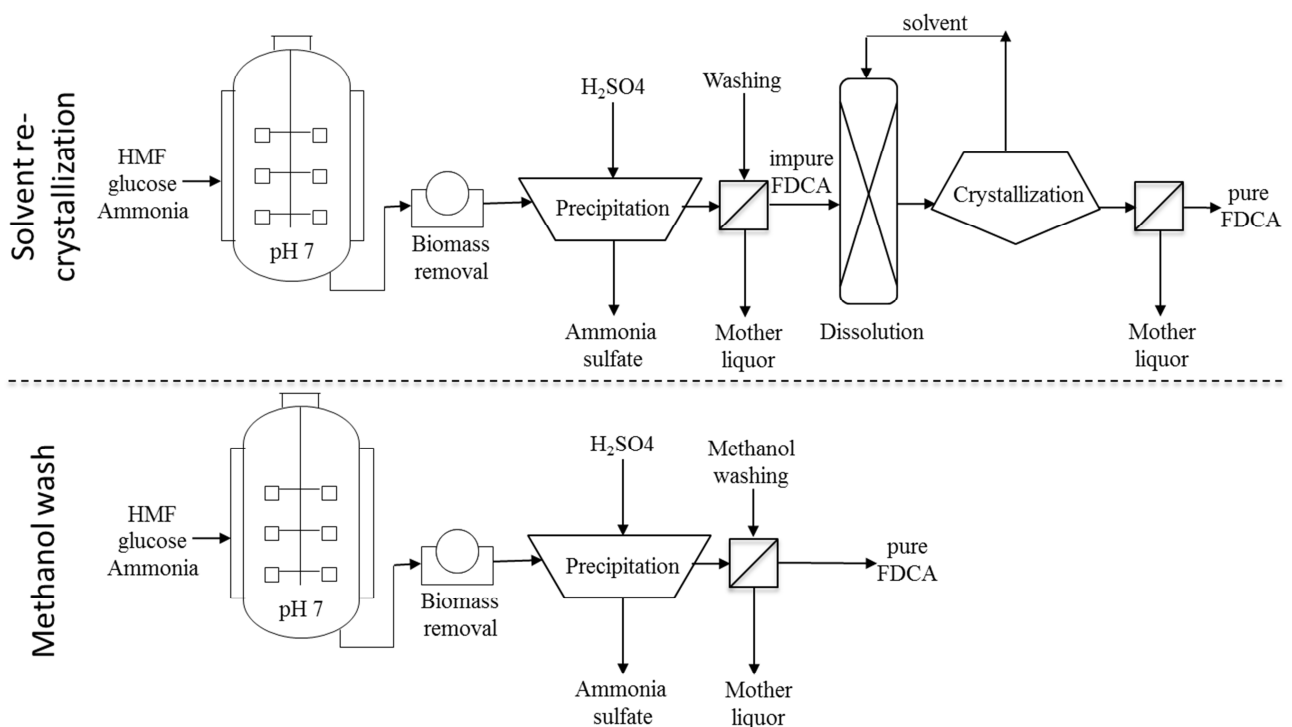

Figure 6: Process options evaluated for further process selection to produce FDCA at pilot scale (in the solvent re-crystallization option, 2 solvents were considered: DMSO and super heat water)

The processes described in the Figure above were evaluated at lab scale and a pre-feasibility study was done by **TNO**. Based on the results at lab scale and from the high-level feasibility evaluation it was concluded that the best process option to be scaled up was the production of FDCA by fermentation and its recovery by precipitation followed by super heat crystallization. This conclusion was complemented and supported with the results obtained by the application test done by Evonik.

Itaconic acid

Itaconic acid, or methylene succinic acid, is an unsaturated acid with conjugated double bonds and two carboxyl groups. Because of its unique structure and characteristics, itaconic acid and its ester are useful materials for the bio-industry. It is used for the synthesis of fibres, resin, plastic, rubber, paints, surfactant, ion-exchange resins and lubricant³. Based on its industrial potential it was selected by the Department of Energy in the USA as one of the 12 building blocks chemicals, which are the most interesting bio-based building blocks to be produced in the biochemical industry. With respect to the developments reached in the itaconic acid chain within BioConSepT, **TNO** could achieve a significantly improved productivity of 1.1 g/L/h with a titer of 74 g/L itaconic acid with *Aspergillus. terreus* strain on mineral medium. In regard to feedstock optimization **TNO** tested different 2nd generation feedstocks as growth-medium for *A. terreus* (C6+C5 feedstock (ADM), 'organosolv' lignocellulosic feedstock from beech wood (**Fraunhofer IGB**)). Although no itaconic acid production was achieved, valuable information was collected about what factors are critical for the production of itaconic acid with *A. terreus*. **Clariant** could improve the cultivation conditions at the L-scale to produce quantities of itaconic acid > 35 g/L on 1st and 2nd generation feedstock using *A. terreus*. In addition, **Clariant** achieved the production of itaconic acid concentrations > 10 g/L with 2nd generation strain based on *Aspergillus niger* developed by **TNO** using a 2nd generation feedstock (sugar beet hydrolysate).

To recovery itaconic acid from the fermentation broth, different DSP techniques were evaluated within the project being adsorption, solvent extraction and crystallization as the most interesting ones. In the case of adsorption, **VITO** completed the earlier screening of sorbents/resins with an improved product supplied by **Clariant**. Sorption capacity and isotherms were determined. From a total of 22 screened products, 4 were retained for further test work. Furthermore, 5 different regeneration strategies were evaluated. For the same 4 products, column tests were performed to determine the sorption capacity and recovery with the best regeneration method. Though recovery was close to 100%, the degree of concentration of the acid in the regeneration solution was rather low. In the case of solvents extraction, Liquid-Liquid extractive based techniques were evaluated by **VITO** for the recovery of IA at pH < pKa. Compared to the physical extractants composed of the pure diluents, reactive extractants gave much higher extraction yields. For a 65 g/l IA solution, extraction efficiencies up to +99% and partition coefficients above 200 were achieved. Finally, several configurations were investigated to recover itaconic acid from low and neutral pH fermentations. Recoveries up to 80 %wt have been achieved by **TNO** with the use of freeze crystallization to recover IA from fermentation broth.

³ Milson, P.E., Meers, J.L. Comprehensive Biotechnology, The Practice of Biotechnology. 1985 vol. 3. Pergamon Press, Oxford, UK, pp. 681–700.

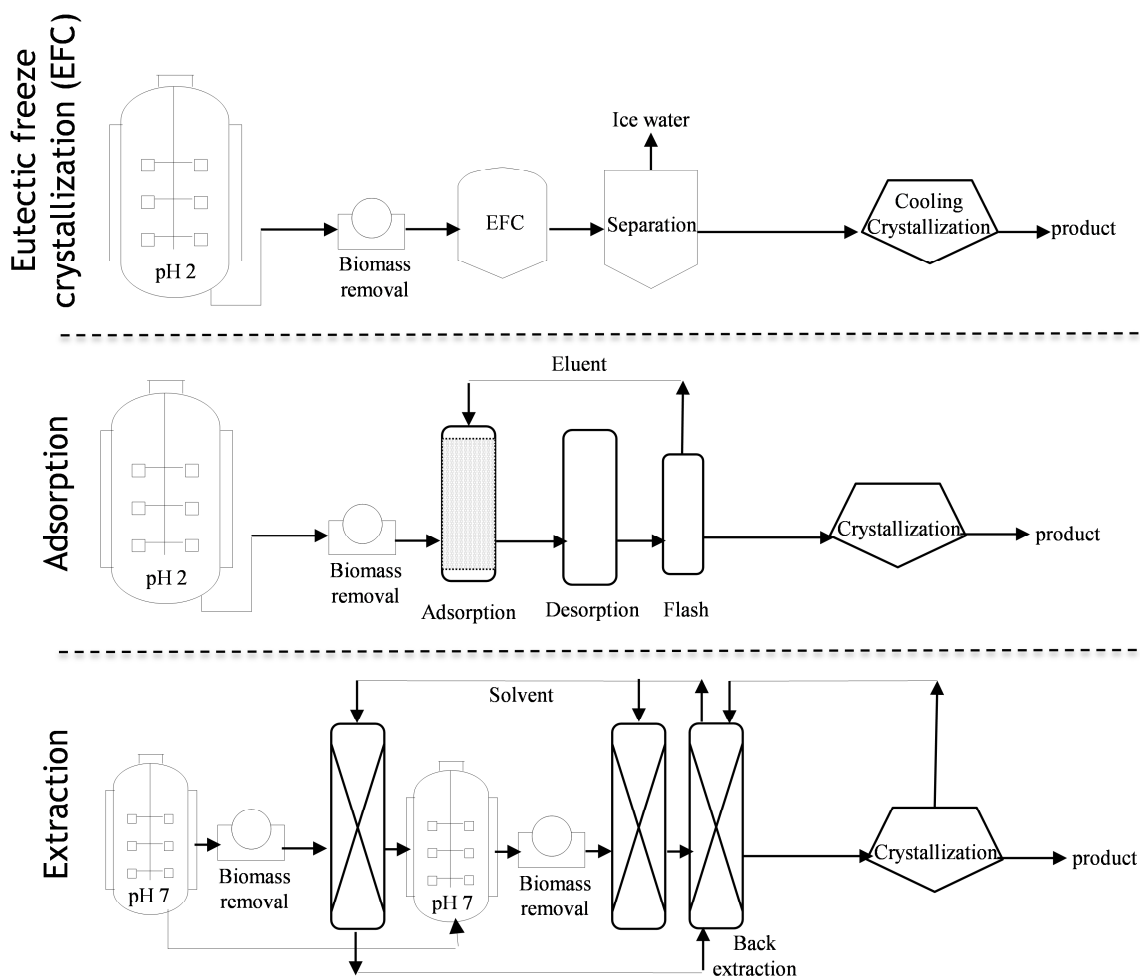

Figure 7: Schemes of the 3 main processes developed at lab scale for Itaconic acid production

Purification technologies as adsorption regeneration, back extraction and crystallization were evaluated after recovery was applied as explained in previous paragraph. For sorption, **VITO** and **Clariant** found that the sorption recovery was found to be nearly complete, and a recyclability in several successive steps was proven. The average concentration obtained after desorption was found to be almost 3 times as high as the feed solution. In view of the capacity of the sorbents, sorption was considered to be more promising to recover itaconic acid from a side stream. In the case of reactive extraction, 3 different types of back extraction procedures were tested by **VITO** and **GTVT**. Finally, when purification by crystallization was evaluated by **TNO**, it was found that an additional purification can consist of a second eutectic freeze crystallization or a cooling crystallization. Both purification processes were investigated and cooling crystallization was found to be the best purification technique and to deliver the required quality for further esterification.

During the last phase of the itaconic acid chain, the process of fermenting *A. terreus* at low pH conditions to produce this acid and its recovery and purification by crystallization was tested at bench scale between 3 and 5 L. This is the first process scheme which is represented in the above Figure 7. The data obtained during the bench scale test was used to validate the studied process in SuperPro Design® by **TNO** and to obtain a techno-economic evaluation of the process at the scale of 25 Kton. This evaluation showed that the process is technically feasible and will produce Itaconic acid between 2.5 and 3 euro per kilogram. The techno-

economic evaluation was also used to understand which part of the process needed further technical development. Itaconic acid samples produced at the bench scale test by **TNO** were sent to **Lucite** for further application test on the production of methyl methacrylate (MMA). MMA samples were produced in the application test and they are shown in the Figure 8.

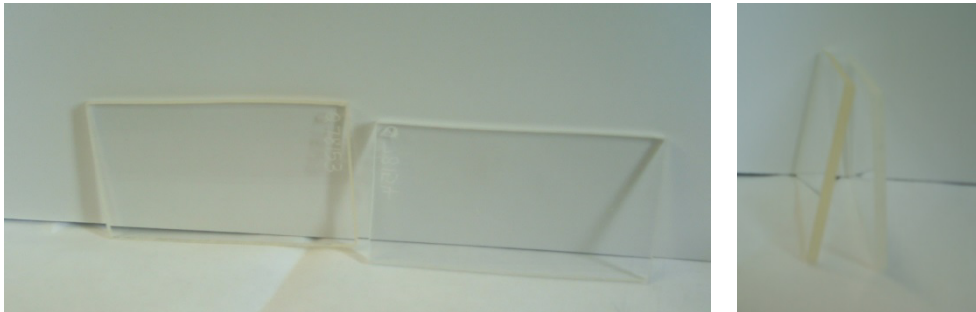

Figure 8: MMA samples made of Itaconic acid sampled from bench scale test. Yellowish MMA was made of itaconic acid from BioConSepT and light MMA with commercial itaconic acid

Despite the fact that the bench scale test and techno-economic evaluation showed that the itaconic acid process developed in the project was ready for pilot scale, other value chains were having good results as well and were more interesting for the BioConSepT industrial partners. Therefore, it was decided to stop the itaconic value chain at this stage and continue the improvement of the developed process in another project (BioQED EU project).

Succinic acid

Succinic acid is considered a top priority value added molecule from biomass from the Department of Energy in the USA in 2004. It can be produced from sugar-based resources in a fermentation process. A major challenge is the development of low cost processes, to become competitive with the petrochemical route. BioConSepT addressed this by investigating the use of alternative feedstocks and integration of selective separation technology for *in-situ* product recovery (ISPR) and/or improved downstream processing. **Designer Energy (DE)** optimized succinate production in batch and fed-batch mode using *Actinobacillus succinogenes*. On synthetic media, succinate titers could be increased to > 45 g/L. Subsequently, raw hydrolysates from different feedstocks supplied by ADM or prepared by DE were assessed. Yields on C6/C5 sugars of unprocessed corn stover hydrolysate were >85% compared to the maximum theoretical yield. Different approaches were assessed for ISPR purposes, suited either for neutral or acidic fermentation conditions.

VITO screened 22 sorbent/ion exchange resins and **GTVT** 2 additional materials for their sorption capacity, and the impact of fermentation by-products and salts. **VITO** demonstrated sorption capacities well over the threshold of 4 mol/kg for selected resins as well as stable sorption-regeneration performance over 5 subsequent cycles. Unfortunately, the results obtained with real fermentation broth did not reach that threshold. As an alternative for recovery at low pH, **GTVT** screened 9 agents for physical, acid and reactive extraction, but the extraction efficiencies remained too low to build an economic case.

VITO investigated a novel concept for succinate recovery through electrodialysis. In selectrodialysis, the proper choice and sequence of ion exchange membranes led to preferential removal of multivalent ions from the fermentation broth, while cations are retained. At increased current density, higher relative transport rates of multivalent ions were indeed obtained, but cotransport of acetate could not be eliminated. In coupled tests, a novel stack design was applied which eliminated the need for intermediate

cell retention. Finally, **GTVT** also developed purification schemes for downstream processing. This resulted in a modified process consisting of adsorption combined with crystallization.

1.3.3. Production of platform chemicals from non-edible oils & fats

Oils/fats (non-edible oils/fats) are a second renewable resource for the production of bi- or multifunctional molecules. Within BioConSepT, they were hydrolyzed into glycerol and fatty acids (enzymatically or chemically). The fatty acids were transformed by fermentation into di-carboxylic acids as well as enzymatically into epoxides. The platform molecules di-carboxylic acids and fatty acid epoxides were further converted into the end-consumer products amines-polyamides, polyesters, polyurethane, coatings and resins. The CO₂, recovered from fermentation processes, was used in an innovative glycerol (side stream of fatty acid production) carbonation process. The results obtained in this chain are summarized in the following sections.

Plant oil-based Epoxides

The chemo-enzymatic epoxidation uses enzymes to catalyze the peroxy acid formation from a carboxylic acid and hydrogen peroxide required for the so-called Prileschajew epoxidation⁴. The enzymatic process can be performed under milder conditions compared to the classical chemical Prileschajew epoxidation and undesired consecutive reactions (e.g. ring opening reactions) can be prevented. In BioConSepT great value was set on expanding the substrate range towards non-edible fractions of fats and oils with lower purity to avoid competition with the food industry. To be able to convert different selected 2nd generation feedstocks efficiently and bring the intermediate epoxidised oils or fatty acids to applications, partners with expertise in enzyme technology, process engineering, conceptual process design engineering, sustainability assessment and product development worked together in an interdisciplinary team. Besides the selection of appropriate low-cost fatty substrates, BioConSepT set a goal on reduction of enzyme costs by investigating optimized heterologous expression systems for the enzyme production in combination with adapted immobilisation techniques.

After selection of suitable feedstock, (see also section 1.3.1) different heterologous enzymes were provided by **CLEA Technologies** and **Eucodis Bioscience** as free and immobilised variants and were tested with regard to the formation of epoxides from waste stream oil provided by **Proviron** and fatty acids and compared with Novozym® 435 by **Fraunhofer IGB**. At **Fraunhofer IGB** process conditions like solvent usage, hydrogen peroxide, and enzyme dosage, as well as technically relevant factors like stirrer geometry and speed, were analysed and optimised with one focus to obtain satisfying epoxide yields to meet product specifications that have been recommended by **Proviron** as an industrial partner in the field of applications. The second focus from Fraunhofer IGB during process optimization for the 2nd generation waste oil was set on investigations regarding stability and recycling of the used biocatalysts that resulted in a further decrease of production costs of the epoxidised product. The DSP that was used to purify epoxides during the RTD activities included a decantation step to separate excess of the aqueous hydrogen peroxide phase and the epoxide containing organic layer, a washing step with water to remove traces of H₂O₂ from the organic layer and a subsequent distillation step to remove the organic solvent. This basic procedure was evaluated at **Fraunhofer IGB**. These RTD activities resulted in a basic process scheme and information on process

⁴ Björkling 1990, Prileschajew 1999

conditions that were used by **Fluor** to develop a commercial scale conceptual design including a reaction, a solvent recovery, a polishing and a storage section. Furthermore, the information was used by **Pöyry** for a sustainable assessment. Finally, the process was transferred to pilot scale by **Fraunhofer IGB** and **Proviron** to demonstrate the applicability of the whole process chain on an industrially relevant scale (see also section 1.3.5).

Long-chain dicarboxylic acids

One of the target products of the project in the Oils & fats chain, the long-chain dicarboxylic acids (LC DCA) are produced by functionalisation of fatty acids present in the vegetable oils. These fatty acids are classified as saturated (without double bond within the molecule) or unsaturated (with at least one double bond within the chain) and the corresponding functionalized products Long-chain (LC) dicarboxylic acids (DCA) can be used as monomers for the synthesis of industrially relevant polymers such as polyesters and polyamides. For example, the unsaturated LC-DCA could be suitable for polyester synthesis. However, if the double bond is reactive in polymerization conditions it will start a radical polymerization leading to a final product with unconventional characteristics. The thermo- and mechanical properties of unsaturated LC-DCA based polyesters are different from polyesters obtained from saturated DCA of the same chain length and could be of interest for the production of polymers and materials with new and innovative properties.

Unsaturated LC DCA can be produced by chemical means from unsaturated fatty acids; however, the drawback of this manufacturing approach is the generation of by-products and thus costly purification of the targeted products is required. This has led to an increasing interest to produce LC DCA by microbial fermentation⁵. There are already several companies producing LC DCA by this biotechnological route, however, primarily in China. This is due to the fact that the yeast used in the fermentation process, *Candida tropicalis*, is classified as a pathogenic microorganism in Europe, hindering large scale industrial production with this yeast. This background guided the BioConSepT project to focus on development of alternative yeast hosts for LC DCA production. The consortium partners **Fraunhofer IGB**, **Novamont S. p. A** and **VTT Ltd** identified three suitable yeast species for this purpose; *Yarrowia lipolytica*, *Pichia guilliermondii*, and *Candida cloacae*. The first-mentioned yeast has been engineered in literature for this purpose, however, not yet meeting the production levels of *C. tropicalis*⁶.

One of the first modifications needed for efficient production of LC DCA by a yeast host is the disruption of its catabolic pathway for fatty acids, i.e. the cellular pathway needed to break down fatty acids for growth, otherwise the provided fatty acids will not accumulate as the desired products. The pathway is quite complex, and different options to inactivate it were assessed in the project targeting in simplifying and speeding up the development. Additionally, the cellular pathway to produce the LC DCA from fatty acids was modified to enhance the synthesis. It needs to be noted that engineering of these somewhat exotic yeast species was more challenging and time-consuming than anticipated, and the partners applied and developed novel tools and approaches to tackle this challenge. The modified *Yarrowia lipolytica* strains generated by **VTT Ltd** were tested for production of LC DCA on model substrates, i.e. pure oleic acid (C18 chain length) and pelargonic acid (C9 chain length), but also on 2nd generation, technical grade raw material; High Oleic acid Sunflower Oil (HOSO). Some encouraging success was achieved; 5 g/L of C18 DCA was produced (~25% of the

⁵ Huf S, Krügener S, Hirth T, Rupp S, Zibek S. 2011.. Eur. J. Lipid Sci. Technol 113: 548-61

⁶ Nicaud JM, Thevenieau F, Le Dall MT, Marchall R. WO/2006/064131 (2006)

target set at the beginning of the project), with yield of 0.35 g/g, however, significant further development is needed to meet industrially interesting performance. The latter substrate, pelargonic acid, is highly toxic for the cell, and very moderate titres were obtained in batch mode cultures; 0.15 g/L of azelaic acid, calling for in particular the production process development. At **Novamont S. p. A.**, three *Candida cloacae* strains, reported deficient in the fatty acid degradation pathway were cultivated in small scale (1L) bioreactors in different conditions with oleic acid feed. Even though encouraging results were obtained, 7.8 g/L of C18 DCA with ~0.13 g/g yield, significant improvement in the performance is needed. **Fraunhofer IGB** has carried out the sequencing of the whole genome of *Candida cloacae* for allowing accurate genetic modifications of the strain, but unfortunately the species seems to be recalcitrant to site specific recombination, leading to the conclusion that genetic modification of this species is time consuming and challenging to achieve.

Development and optimisation of the fermentation process were carried out by **Fraunhofer IGB**. Optimised culture regimes resulted in high productivities with the *Candida tropicalis* yeast (presently under consideration for re-classification as *Candida cenacerosene*; if successful, paving the way for an industrial process). **Fraunhofer IGB** showed successful conversion of different fatty acids with different chain length and amount of double bonds (C9, C16, C18:1, C18:2, C18:3, C20:1, C22:1, C24:1) to the corresponding LC DCA. Pure fatty acids and also mixtures of fatty acids were shown to be converted within the cultivation process. Fermentation on oleic acid and 2nd generation technical grade oleic acid with impurities showed high titres of 100 g/L, resp. 40 g/L, with ~0.5 g/L/h productivity. Additionally, conversion of pelargonic acid to azelaic acid was improved with different feeding strategies to avoid accumulation of this toxic substrate (toxicity dose 1.5 g/L) The final titer was 3 g/L. Product recovery, primarily for C18 unsaturated DCA was developed by the partners **Fraunhofer ICT** and **TNO**. The product was first enriched from the fermentation culture broth and further purified with proven DSP technologies. This development has resulted in a patent application.

In spite of the fact that the novel yeast strains did not yet perform optimally, it was decided to continue the development efforts and to provide a proof-of-principle for the full chain on a smaller scale. **Fraunhofer IGB** carried out the fermentations with the *Candida* strain, with oleic acid feed, and provided the growth medium broth, containing the C18 unsaturated LC DCA, to **Fraunhofer ICT** and **TNO** for product recovery and purification, respectively. The obtained material was provided to **Novamont S. p. A.** for quality control tests and the results showed that the level of purity of the C18 unsaturated DCA differed from polymer grade products. Thus, polymer grade C18 unsaturated DCA, available outside of the project, was used as a model molecule to perform polymer synthesis tests both at lab and pilot scale. C18 Unsaturated DCA was mixed in specific ratios with azelaic acid, a renewable saturated dicarboxylic acid, in order to reduce the extent of side reactions due to the double bond. The co-polyester polymerization reaction is a reproducible process that can be scaled up to obtain a product with consistent properties. The co-polyester showed unconventional characteristics leading to conclusion that it could be a good base for developing innovative formulations intended to be used as adhesives, hot melts, and elastic materials.

Long-chain diamines

Diamines are important building blocks for the synthesis of polyamides. Hence, **Fraunhofer ICT** investigated the chemical conversion of LC DCA towards amines. To deliver amines, there are different routes feasible, of which the reduction of nitriles was selected as the key route.

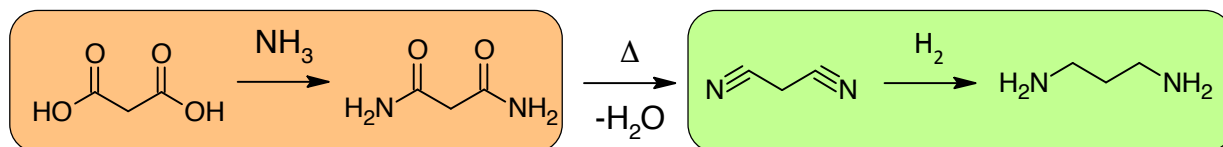

Figure 9: Reaction pathway from LC DCA to Diamines

As shown in Figure 9 the nitriles are reduced in-situ to the corresponding amines. While the synthesis of the precursor amides has been demonstrated already by others and also **Fraunhofer ICT** in prior works, the formation of the nitriles and the following reduction could not be investigated in the shown single reaction steps, as the intermediates could not be isolated during the reaction. Furthermore, in the used apparatus, the needed high temperatures for the dehydration of the amides to the nitriles could not be achieved and formed water could not be removed, which is detrimental for the nitrile synthesis. To be able to investigate and optimize the key reduction step (green box), commercially available nitriles were employed. As the biotechnological production of LC DCA from C18 was investigated by **Fraunhofer IGB**, C18-DCA was chosen as one of the relevant molecules. Besides this, commercially available long chain mononitriles (fatty acid based 1-Octadecannitrile and 1-Decannitrile) were selected. Furthermore, the already commercialised biobased sebacic acid was chosen as key molecule as all relevant derivatives (diacid, dinitriles,...) are available at the market.

The chemical conversions were performed utilizing heterogeneous activated base metal catalysts (e.g. Raney Nickel, Copper and Cobalt). The focus of the work was to find suitable parameters and to optimize the conversion. After the experimental work with the mononitriles was successfully finished, the focus of the work was shifted towards dinitriles. These should, in general, react in the same way. Nevertheless, due to the bifunctionality, side reactions might occur and need to be investigated. As an additional topic, the synthesis and isolation of the C18-dinitrile should be evaluated. Nevertheless, it turned out that the direct nitrile synthesis could not be operated in the available equipment, and that this could also not be adjusted to work under the necessary conditions ($T > 500\text{ °C}$ and high pressure). As the synthesis in general is known and performed by the chemical industry in large scale the nitrile synthesis was not investigated furthermore. As **Fraunhofer ICT** was involved in the DSP as well, a shift of work needed to be performed, to set the fundament for material supply. However, by choosing sebacic acid as available long chain biobased bifunctional molecule, a successful proof of concept for the reduction of the dinitriles could be achieved. By doing this, it could be demonstrated that the developed chemical synthesis can be transferred from the mononitriles to the dinitriles.

Biosurfactants

Most surfactants are still synthesized chemically from hydrocarbons. Biosurfactants can be obtained either by chemical or enzymatic synthesis or via fermentation with special microorganisms by using renewable resources. Currently, biosurfactants are present only in niche applications, due to high production costs or limited properties making them applicable for specific purposes only. BioConSepT initiated biosurfactant activities by testing known and newly identified biosurfactants for their use in different fields of application. The objectives included the identification of suitable biosurfactant variants and microorganisms for the efficient production, as well as the optimization of fermentation parameters to obtain high space-time-yields starting from 2nd generation feedstocks.

The microbial fermentation process was optimized by **Fraunhofer IGB** focusing on the production of the three promising biosurfactants Mannosylerythritol Lipids (MEL) and Cellobiose Lipids (CL) from 2nd generation sugar and oil substrates in up to 30-L-bioreactors. **Leitat** was focusing on the production of Sophorolipids (SL). Genetic engineering of biosurfactant producing microorganisms was also included in the objectives but not further investigated as on the one hand production titers of MEL, CL and SL were good and, on the other hand, most cosmetic companies prefer the application of natural wild-type strains. Post-modification (enzymatic and alkaline treatments) of these biosurfactants led to biologically produced surfactant variants with e.g. altered polarity and water solubility and therefore to an extended scope of application. Sample material of MEL, CL and different derivatives thereof was produced by **Fraunhofer IGB** and delivered to **Rhodia-Solvay** for application tests, e.g. in products like cosmetics and home care applications.

Glycerolcarbonate

VITO and **SuniLei** investigated the chemical synthesis of glycerol carbonate from glycerol and pure CO₂. They screened several basic heterogeneous catalysts and selected the best performing one. **Sunilei** investigated the reaction at low CO₂ pressure, **VITO** at high CO₂ pressure. However low yields were obtained, which was attributed to stringent thermodynamic limitations. Therefore, alternative routes were developed and screened. **SuniLei** investigated the reaction using a new solvent/catalyst system resulting in higher conversion rates as compared to the state of the art. **VITO** focused on enzymatic screening experiments together with **EUCODIS** and the simultaneous dewatering, providing a proof-of-concept of the enzyme selected by **EUCODIS** for the production of glycerol carbonate.

1.3.4. In-situ product removal (ISPR)

In BioConSepT, several concepts were investigated to achieve In Situ Product Recovery (ISPR) for improving the fermentation performance. At first, several process schemes were developed by **VITO** and **TNO** covering the different steps of the recovery and purification of the main platform molecules, being succinic acid, itaconic acid, FDCA and the long-chain dicarboxylic acids. For each of these molecules the three most promising schemes were identified, ensuring compatibility with the fermentation and providing a firm link with the research performed on the further downstream processing to obtain the required purity for the applications. To achieve improved cell retention, **Applikon** and **TNO** developed successfully a special 3L airlift bioreactor for fungal growth in pellets. This new system was investigated for fungal cultivation and has possibilities for ISPR by the retention of the cells. Furthermore, three submerged membrane bioreactors design options were evaluated for continuous fermentations of succinic acid in collaboration with **VITO** and **Zena**. The final concept integrated a dedicated **Zena** hollow fiber membrane module design in a housing, which in itself was placed outside the fermenter. Key success factors for successful bioreactor design with ISPR were the intelligent mechanical design for hydrodynamic conditions (avoid fouling of membranes and enable pelleted growth) and the optimization of instrumentation around the bioreactor (sensors, pumps etc) to benefit from reaction kinetics for higher productivity. Recommendation for the future developments are more emphasis on the development of cell retention devices that are scalable, sterilizable and cleanable and have low operating costs. Furthermore, also extensive research was performed on the separation technique for ISPR recovery of the various platform molecules. The selection of the ISPR-techniques was primarily based on the pH of the fermentation. Therefore, ISPR-techniques were selected based on two main approaches, either recovery of the charged molecules by electrochemical or ionic interactions with

chemicals or sorbents or recovery of a precipitate by using the typical strong decrease in solubility after acidification. On the other hand, itaconic acid, as well as succinic acid, can be fermented at “low” pH, whereby the molecule primarily is in its “uncharged” form. Therefore ISPR-techniques were selected based on crystallisation by **TNO** and L-L (reactive) extraction and sorption by **VITO**.

VITO investigated 2 technologies for ISPR succinic acid/succinate recovery. For a fermentation at low pH, sorption was evaluated. From 22 screened sorbents and resins, several performed well on synthetic succinic acid solutions. However, tests with real fermentation broth showed a strong reduction in sorption capacity, well below the 4 mol/kg threshold for an economic process. Therefore, no attempts were made to execute integrated tests. For a fermentation at neutral pH, electrodialysis was the technology of choice. Here, 2 novel concepts were investigated. In selectrodialysis, the aim was to selectively remove multivalent ions from the fermentation into a concentrate compartment. In a second concept, a novel stack design was evaluated for conventional electrodialysis. This allowed to directly circulate the fermentation broth to the electrodialysis stack, without intermediate cell retention step. Offline tests showed that it was possible to increase succinate concentrations to 60 g/L in the concentrate compartment. Integrated tests were executed as well and a proof-of-concept for direct coupling was obtained without clogging issues. Organic acid recovery was achieved but prevention of contamination is a critical issue during continuous operations. Furthermore, **GTVT** tested re-precipitation to recover succinic acid. The tests were carried out with artificial as well as real broths. The achieved average efficiencies of the separation of succinic acid in a crystalline form were on average 98%.

For the ISPR recovery of FDCA from the fermentation broth, **TNO** investigated electric induced crystallization (EIC) onto a rotatory electrode. Through the use of a rotational anode, the produced FDCA crystals are continuously removed from the liquid and ISPR operation can be achieved. Proof-of-concept experiments were performed in order to demonstrate the viability of this concept and a crystal layer was successfully obtained (see Figure 10).

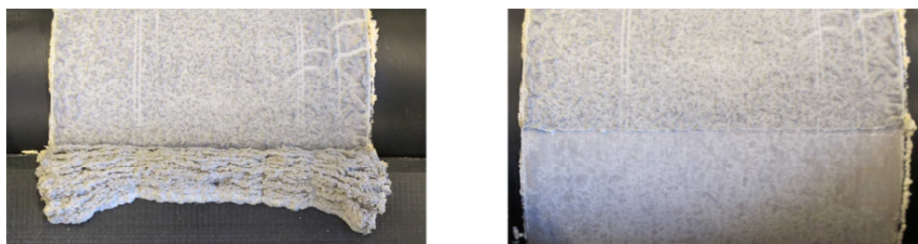

Figure 10: Formation and recovery of FDCA crystals by EIC; left: with a scraper; right with the scraper demounted from the setup

The apparent optimal conditions for FDCA recovery were determined from experiments at constant pH while changing the current density and rotational velocity. The acid consumption (for maintaining constant pH) was taken as an indication for the FDCA production. Furthermore the influence of pH-stabilization was investigated at the optimal conditions. Additionally, Sorption was also investigated by **VITO** to recover the **FDCA** from the fermentation broth after cell retention. A range of 22 sorbents/resins was screened for their FDCA sorption capacity at a pH 7.5, as applied in the fermentation process. Several promising sorbents, mostly strong base resins, outperformed the required sorption capacity threshold for building an attractive economical case. However, since FDCA is produced in the fermentation at high concentrations close to the solubility limit, the application of sorption was considered not to be interesting at these conditions.

For the ISPR recovery of Itaconic acid from the fermentation broth at low pH, eutectic freeze crystallization was investigated by **TNO**. A new crystallizer was designed where water could be crystallized in a controlled way and the IA crystals could be recovered in a continuous way (see Figure 11). Moreover, the set up contained a special lid, allowing the continuous removal of ice crystals.



Figure 11: Left - Freeze crystallizer set up design; Right – Freeze crystallizer filled with fermentation broth containing IA.

Experiments were done with water-IA mixtures and real fermentation broth containing IA. The recovery yield was shown to be 75-80%, with no incrustations of itaconic acid into the ice crystals. Moreover, **Clariant**, and **VITO** evaluated ISPR to recover itaconic acid by sorption. After having established the most promising sorption step through sorbent screenings, determination of isotherms and the performance of column tests with both artificial and real broths, first tests were made for the establishment of a continuous ISPR of itaconic acid during the fermentation. Itaconic acid could be removed from the fermentation broth during the fermentation with *Aspergillus terreus* at the L-scale. The process had neither a negative nor a positive impact on the fermentation and left it intact with an equal performance as the reference fermentation. Finally, also L-L reactive extraction was investigated by **VITO** for the ISPR recovery of itaconic acid. Special attention was paid to select an extractant compatible with the fermentation broth. The extraction yield of this new system was found to be a bit lower than the more conventional extractant composed of trioctylamine and octanol. Nevertheless, the new extraction system was less affected by the other constituents in the fermentation medium (salts) and the extracted itaconic acid was found to be more easily recovered from the extractant. The overall yield of the full process composed of extraction and recovery was shown to be 85-90%, making it equally well performing as the conventional system, but with reduced impact on the fermentation broth.

For the purification of LC DCA different techniques were tested by **Fraunhofer ICT** and **TNO**. The different methods were evaluated at lab scale and the ISPR potential was assessed. In the project, a combined purification strategy, compatible with an ISPR setting, was successfully developed. The methods were demonstrated in batch mode up to a 25 L fermentation-scale. The procedure consists of two steps. While the first removes the long chain acids (monoacids and diacids) from the broth unselectively, the second purifies

the LC DCA up to polymer grade purity. The purification methodology is currently under evaluation for patenting, so that no detailed info can be given to avoid pre-filing disclosures.

1.3.5. Demonstration of 2 processes on pilot scale

Microbial conversion of impure HMF process water to FDCA

Production and purification of FDCA were first developed from concept to lab scale, giving very promising results as described in section 1.3.2. Not purified HMF process water of AVA-Biochem was used for the process development from lab to pilot scale. The lab scale results gave very innovative and promising results and that is why the FDCA chain was selected as one of the two value chains to be demonstrated at pilot scale. After discussing application test results and process developed (section 1.3.2), it was concluded by the FDCA value chain team, that the most promising techniques to recover and purify FDCA were precipitation and super heat crystallization. Lab scale protocols of these technologies from TNO were transferred to Fraunhofer CBP and pilot scale plan was prepared by the two parties.

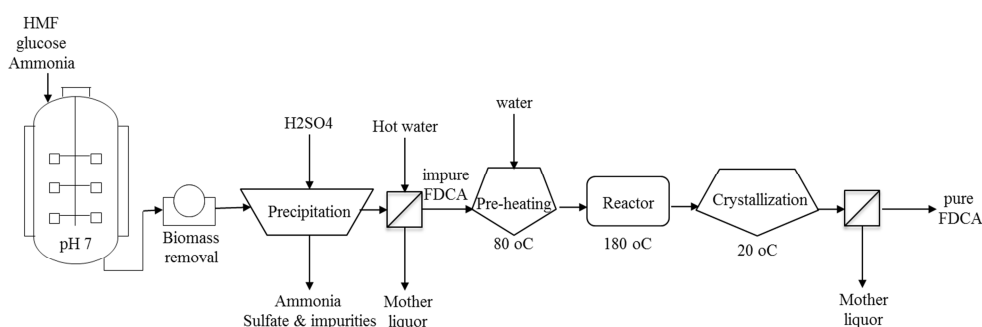

Figure 12: FDCA process scheme developed at lab scale and tested at bench scale

TNO, VTT and AVA Biochem worked closely together with Fraunhofer CBP to optimize the conditions for the FDCA process to achieve an industrially competitive process and test it at pilot scale. Here, VTT developed a bench and pilot scale processes for the fermentation of HMF into FDCA and Fraunhofer CBP did the bench and pilot test for the recovery and purification of FDCA from fermentation broth. The test of the purification of FDCA (super heat crystallization), was very challenging at bench scale. The super heat crystallization configuration presented in the above scheme was tested at the scale of 50 L (see Figure 14) but pumping and pressure problems were encountered which did not allow the further scaling of the technology. It was concluded that another type of crystallization equipment is needed to bring this technology in practice at pilot scale.



Figure 13: Precipitation tanks and crystals obtained after FDCA recovery by precipitation at pilot scale

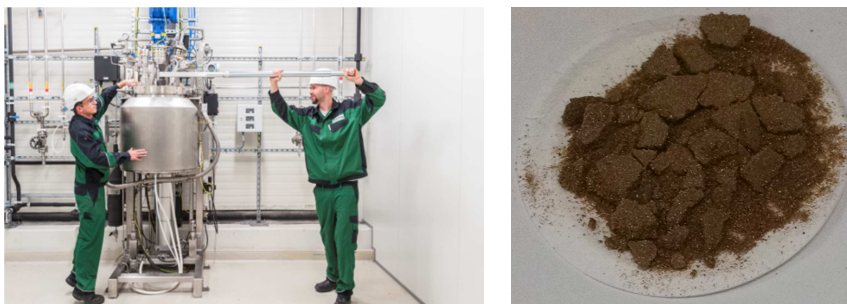

Figure 14: equipment used for super heat crystallization at bench scale and crystals obtained after purification with this technology (purity obtained here is ~95 %wt).

Because it was necessary to purify large amounts of FDCA coming from 1 m³ fermentation broth, the developed super heat crystallization method was not practical. Thus for processing the 1 m³ fermentation broth from VTT containing around 56 g/L FDCA, instead of the superheated crystallization, a re-precipitation with sulfuric acid was used at pilot scale (Figure 15). Therefore, the FDCA crystals after the first sulfuric acid precipitation (pH 0.5) were washed with hot water (90 °C) and dissolved again in water by neutralizing with sodium hydroxide (pH 7).

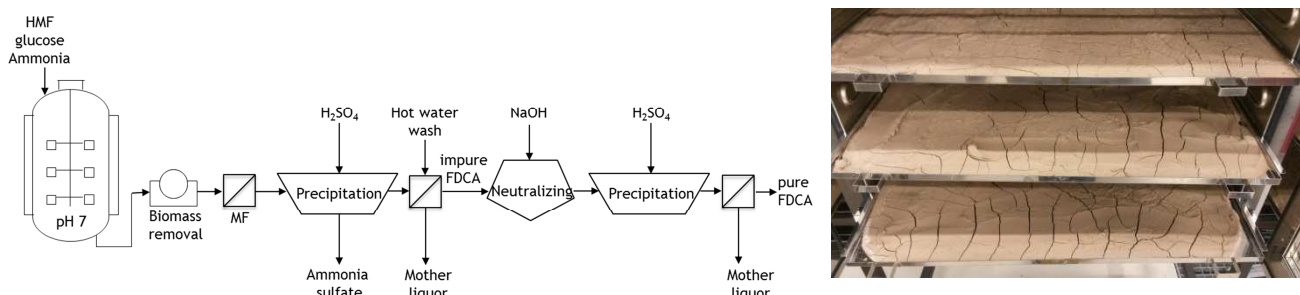

Figure 15: (Left): Scheme for pilot demonstration of FDCA process, (Right): Picture of FDCA processing by re-precipitation with sulfuric acid

Pilot process samples were distributed during the last month of the project and the application partners **Novamont**, **Evonik** and **AVA-Biochem** evaluated the application potential of FDCA with commercial samples showing a big commercial prospect for this molecule.

Enzymatic epoxidation of a 2nd generation waste stream oil

The 2nd process that has been transferred to pilot-scale was the enzymatic conversion of waste stream oil to the corresponding epoxidized oil. Considerations regarding the selection of 2nd generation feedstocks have been already covered in section 1.3.1. Aspects concerning RTD activities to adapt the enzymatic epoxidation to the selected feedstock were described in section 1.3.3.

Based on the successful optimization on lab-scale and evaluation in small scale stirred tank reactors with standard geometry the enzymatic conversion was scaled up to pilot-scale and showed general applicability of the process on industrial relevant size using Novozym® 435 as biocatalyst. The principle reaction scheme is illustrated in Figure 16 (left). The equipment used at **Fraunhofer** including some DSP equipment like the filtration unit and the separation tank for removal of the aqueous H₂O₂ phase are shown in Figure 16 (right). One enzyme batch was filtered off after the reaction had been completed and was recycled for 5 consecutive runs. In the following process step, the two liquid phases were separated in a 100 L glass

reactor. After liquid phase separation, the epoxide containing organic layer was sent the industrial partner **Proviron** for further conversion and application testing. The DSP process that was used in lab- and pilot-scale was discussed with **Proviron** and **Fluor** to transfer it to a continuously running DSP section. The whole reaction and DSP section have been included in an Aspen model and the conceptual process design by **Fluor**.

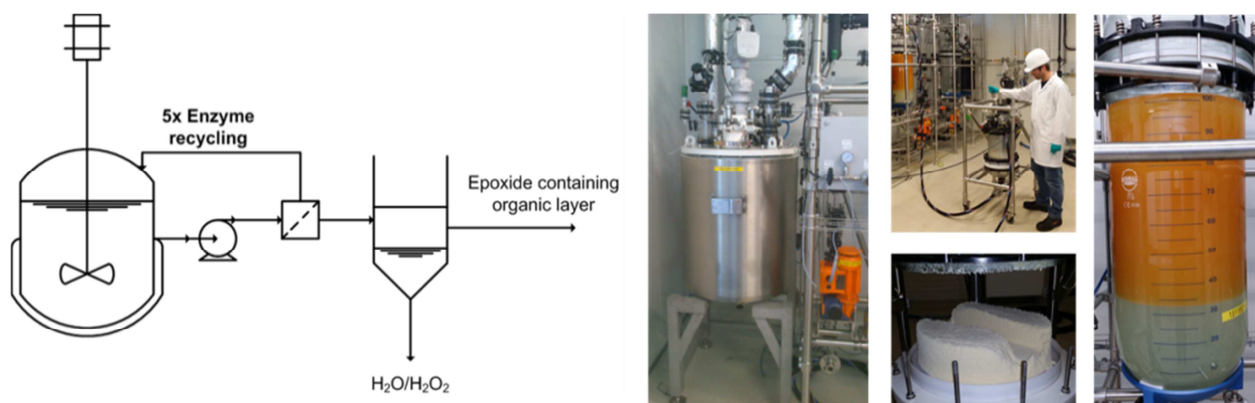

Figure 16: Process scheme (left) and 100 L reaction vessel with filtration unit and separation tank (right) for the demonstration of the enzymatic epoxidation at Fraunhofer.

During demonstration trials, the recyclability of the immobilized enzyme was shown in consecutive reaction cycles resulting in a total amount of 140 kg of epoxidized oil. The epoxide oil was further converted to the final product and evaluated in application tests for the production of a plasticizer at the production site of **Proviron**. The application tests demonstrated very good performance characteristics that were comparable with the performance of standard general purpose alternatives.

1.4. Potential impact

The main objective of BioConSepT was to transfer promising R&D results at laboratory scale to demonstration at industrial relevant scale. Proving the technical and economic viability at larger scale is regarded as a crucial milestone in the trajectory to implementation, where scientific potential is transferred into real economic and societal impact. The choice for 2nd generation biomass as feedstock originates from the vision that the valorization and utilization of residue streams is essential in creating a more sustainable, circular economy. It is also an important stepping stone between the use of 1st generation feedstocks, which may be in competition with the food chain, and the utilization of waste streams as 3rd generation feedstocks in future. To improve the technical and economic potential BioConSepT was built on 4 pillars:

- Development of robust chemical and biotechnological conversions that can cope with the contaminants that are typical for 2nd generation feedstocks,
- Integration of conversion and separation/purification technologies to improve the productivity and yield,
- Demonstration at industrial relevant scale to prove the scale-up potential, to collect key design parameters and to provide sufficient material for application/product development, and
- Developing semi-/end products from the platform chemicals/building blocks produced in BioConSepT in order to create a market pull perspective at the end of the integrated value chains.

In BioConSepT, 6 platform chemicals and 2 side products were investigated. The feedstock was either lignocellulose or non-edible oils & fats and the value chains did not stop at the platform chemicals but also included their application in end-products. In the last phase 2 of the platform chemicals (FDCA and epoxides) were selected for large scale demonstration.

Sustainability combines the potential impact of a product to the economy, environment and the society. In section 1.4.1 the high level results of the LCA/sustainability analyses for the two demonstration platform chemicals will be described. Typical for the bio-based economy is the need for multi-stake holder interaction in order to develop and implement complete, sustainable value chains. This implies that BioConSepT not only stimulated close co-operation between the consortium partners in the value chains, but also found it very important to reach out to the bio-based economy outside the project. The highlights of the dissemination and exploitation activities undertaken by BioConSepT are summarized in section 1.4.2. Information on the project website and the contact details of the consortium can be found in section 1.5.

1.4.1. Potential impact and societal implications

Fluctuating oil prices, concern about the environment and new market opportunities have for years been the major drivers for the development of the bio-based industry. Globally the production of both biofuels and bio-based chemicals is expected to be located in areas where there are large amounts of easily obtainable raw material, low production costs and high political support. In other words, the production which used to be concentrated to Western countries is in danger of moving to Asia and South America unless there are significant advancements in deploying new types of feedstock and new process technologies. As BioConSepT focuses on second generation feedstocks (lignocellulosics, non-edible oils and fats), the key contribution of the BioConSepT project can be considered to be its effort on broadening the feedstock base for bio-chemicals. With a switch to second generation feedstocks such as agricultural residues, the competitiveness of the European bio-based chemical sector could improve.

The global bio-based industry is anticipated to experience strong growth as new processes and products are being commercialised. Based on the market assessments carried out in the BioConSepT project, the demand for building block chemicals is forecast to grow rapidly in the next decade. The combined market potential of the studied building block chemicals – itaconic acid, succinic acid and furandicarboxylic acid – is estimated at 1.3 million tonne in 2020, corresponding to a market value of over 1 billion EUR. The application testing carried out in the BioConSepT project will contribute to the realisation of this market potential as application development is one of the major factors slowing down market development. The progress taking place in the BioConSepT project could also open new applications for the studied chemicals (Figure 16).

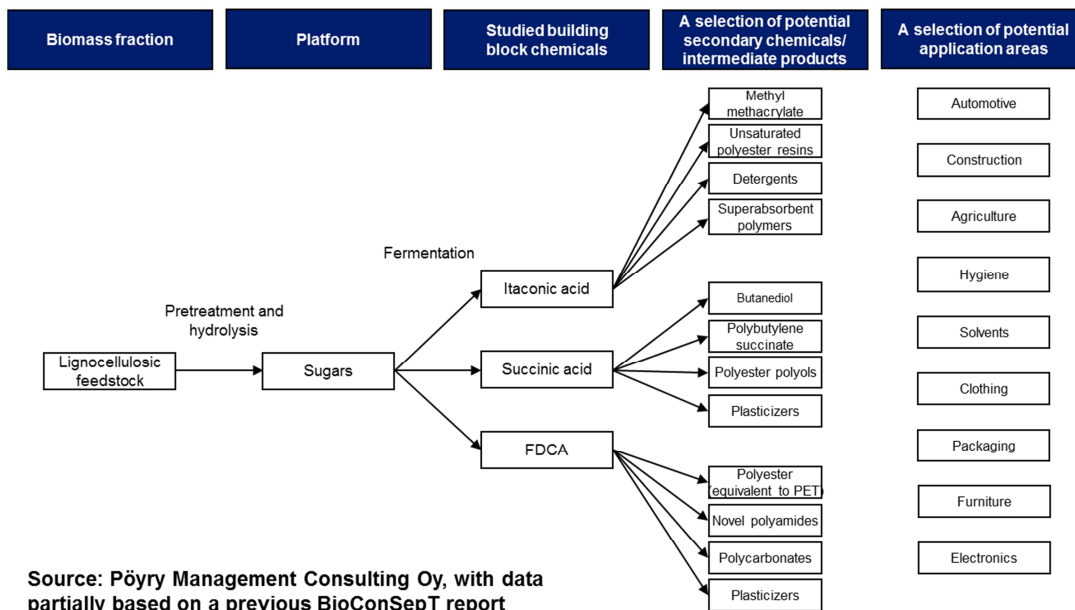

Source: Pöyry Management Consulting Oy, with data partially based on a previous BioConSepT report

Figure 17: A graph of potential secondary chemicals and intermediates that could be produced from the studied sugar-based platform chemicals

The cost of second generation raw materials is another main hurdle to overcome for the anticipated growth to take place. In the various sustainability assessments carried out during the BioConSepT project, the type and cost of bio-based feedstock were one of the most sensitive factors impacting both economic and environmental viability.

Throughout the project, techno-economic and environmental assessments were used to highlight parameters that have strongest impact on economic and environmental viability and factors which could still be improved in process development. Based on research results and first round of techno-economic modelling, furandicarboxylic acid (FDCA) and vegetable oil based epoxides were selected for demonstration and more detailed sustainability assessments. The importance and impact of technological advancements reached in the BioConSepT projects are next illustrated through these two processes (Figure 18 and Figure 19).

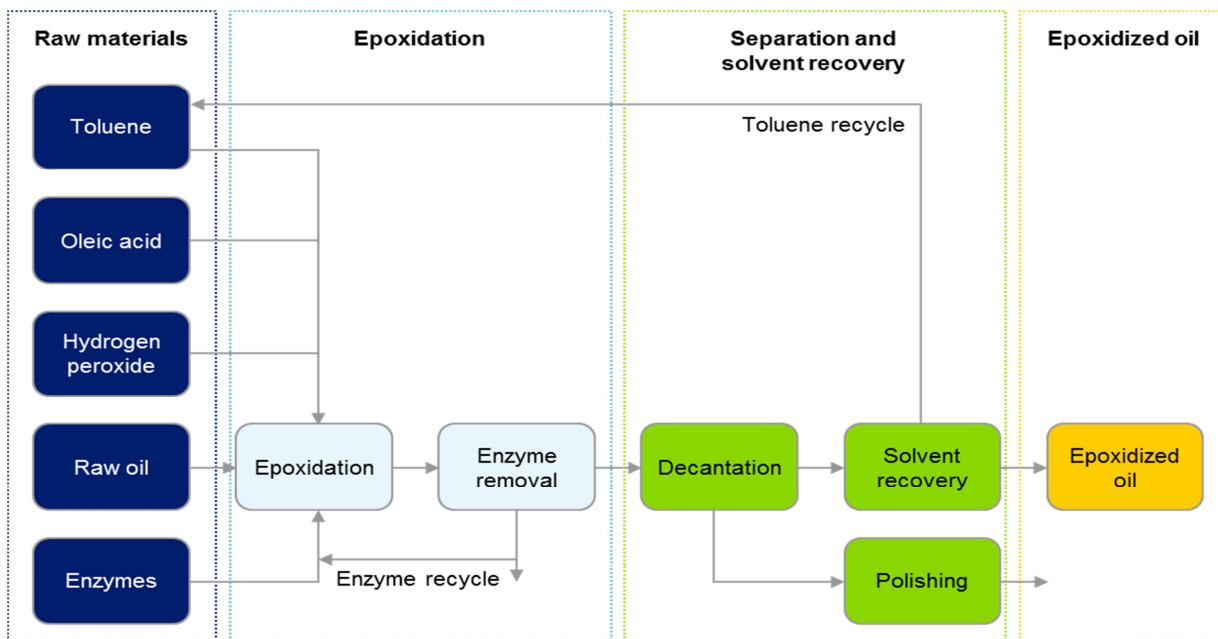

Figure 18: Block flow diagram for raw oil epoxidation process

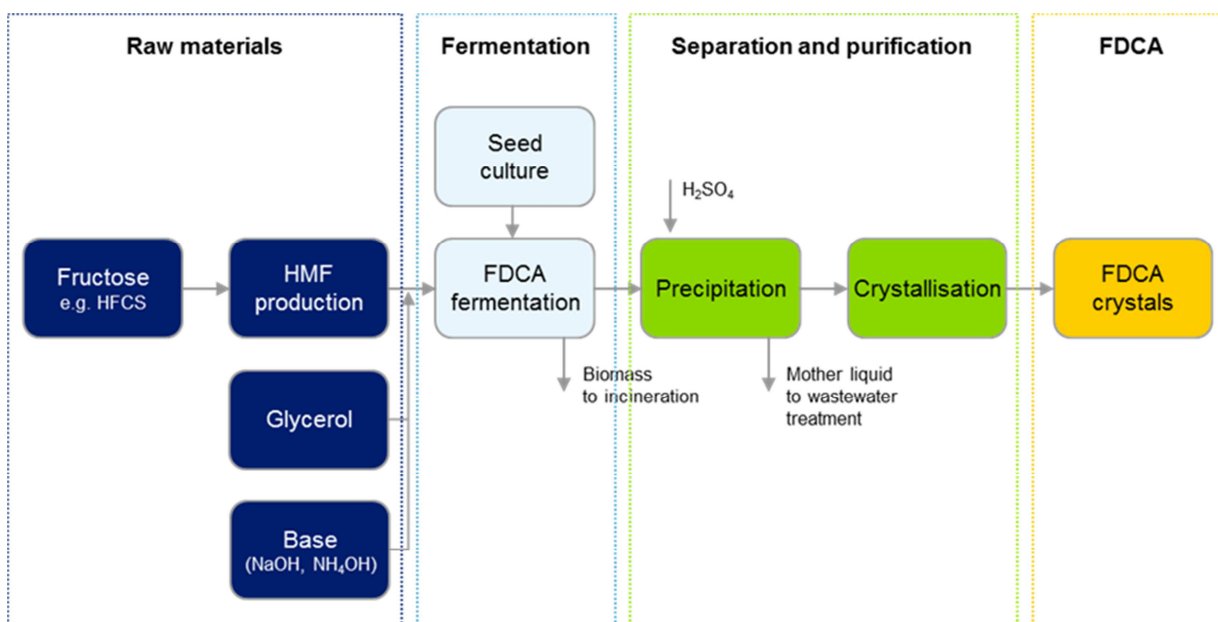

Figure 19: Block flow diagram for FDCA process

The cradle-to-gate life-cycle assessment (LCA) study showed that the environmental performance of the developed process for epoxidised oil is in fact better or on a par with commercial epoxidised soybean oil (ESBO) that was used as a reference. X presents indexed LCA results in terms of Global Warming Potential (GWP), acidification, eutrophication, photochemical ozone and non-renewable primary energy.

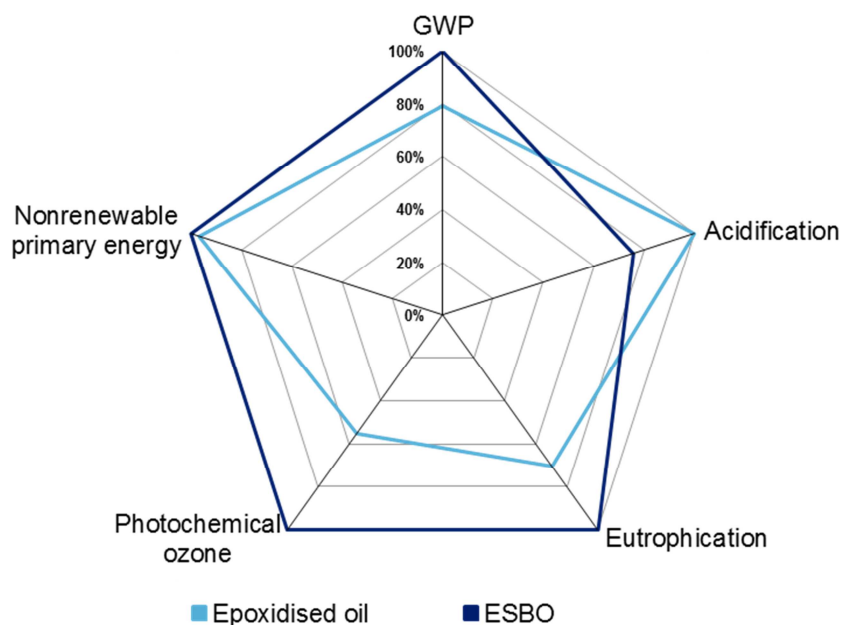

Figure 20: Indexed cradle-to-gate LCA results of epoxidised oil produced through a process developed in the BioConSepT project compared with commercial ESBO product⁷.

With the given assumptions based on experimental pilot-scale results and technical modelling, the base case scenario for the epoxidised oil production showed profitable economics. An investment for a 20 000 t/a epoxidised oil facility would corresponded to an IRR of 12% at a sales price of 1 400 EUR/t. The pay-back time was estimated at 8 years. The total value added (direct and indirect) of said epoxidised oil production was estimated at 14 MEUR/a. In total, the epoxide process would generate 67 new jobs. If all new plants required to meet the growing demand for epoxidised soybean oil by 2020 would be located in Europe and based on the studied technology, it would generate over 330 new jobs and 70 MEUR value added per annum.

Purified terephthalic acid (PTA) and diisononyl phthalate (DINP) were selected as reference products for the life-cycle assessment of FDCA production. The production was also analysed for two different locations; Germany and Italy. Similarly to epoxidised oil, Figure 20 presents indexed LCA results in terms of Global Warming Potential (GWP), acidification, eutrophication, photochemical ozone and non-renewable primary energy. Large alkali and energy consumption in the fermentation-based FDCA production result in high global warming potential. Also several other impact categories are high for the studied fermentation-based FDCA. Comparison with the fossil-based reference products, PTA and DINP, is strongly affected by the underlying assumptions (particularly how biogenic carbon is handled in modelling and whether end-of-life is taken into consideration). Reducing energy and alkali consumption would significantly improve the sustainability of fermentation-based FDCA. Furthermore it should be noted that the impact on sustainability was fully attributed to FDCA. However, the mother liquor after separation of FDCA by acidification of the fermentation broth in the developed process will contain significant amounts of a salt (Na_2SO_4 or $(\text{NH}_4)_2\text{SO}_4$).

⁷ Source for reference product (commercial ESBO): EU-funded COPIRIDE project, Dr. Dana Kralisch, Institute of Technical Chemistry, Friedrich-Schiller-University Jena

In industrial practice, it is likely that the salt will either be used to convert it back by techniques like electro dialysis into acid and base that could be reused in the process and/or the salt will be separated from the mother liquor and sold as by-product. Both options will improve the sustainability performance by reducing the consumption of acid and base and/or because the sustainability effects can be partly be attributed to the by-product. Nevertheless, during the BioConSepT project a FDCA process with a final products cost of 3.5 euro per kilogram was achieved. Despite that this process, is not yet competitive with fossil-based PTA or DINP processes, a 70% reduction of bio-FDCA product costs was achieved by the R&D in BioConSepT. The reference was the 10 euro/kg that was estimated as price for bio-FDCA in the Conceptual Process Designs at the beginning of the project. The cost reductions achieved in BioConSepT were driven by a strong reduction of the raw material costs for 5-HMF by using impure HMF process waters instead of pure HMF and by the novel purification technologies developed and tested in BioConSepT. However, further cost reduction to achieve a FDCA cost of 2-3 euro per kilogram will be needed. This cost reduction should come from further decrease of the costs of feedstocks (HMF), optimization of the fermentation and separation/purification steps and valorisation/reuse of the salt present in the mother liquor after the acidification step. The studied FDCA facility was assumed to employ a total of 240 persons (directly and indirectly).

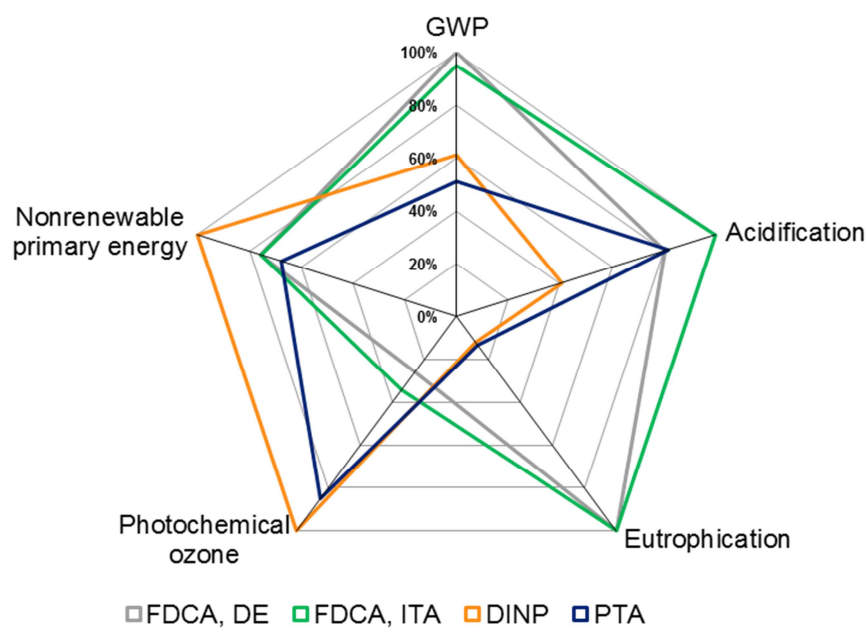

Figure 21: Indexed cradle-to-gate LCA results of FDCA produced through a process developed in the BioConSepT project compared with commercial references purified terephthalic acid (PTA) and diisononyl phthalate (DINP)

In addition to significant advancements in studied production chains, the supporting joint research between bio-based chemical producers and different end-use industries promotes the development of new high-value applications and innovation as well as creates new markets. The BioConSepT project has been a primary example of efficient collaboration between European research institutes, process developers and global chemical industry players enabling new competitive bio-based products to the market while improving the competitiveness of the EU region.

1.4.2. Main dissemination activities and exploitation

Within the lifetime of BioConSepT various dissemination activities promoted the project and facilitated the transfer of project foreground to different target audiences. The full list of all activities is provided in chapter 2 (Tables A1 + A2), the following description highlights only the most relevant dissemination achievements in this regard.

New media, social media and interactive tools:

The project website (www.bioconsept.eu) was the central hub of project information. Besides the news items, an event list and linked social media accounts, a tag cloud supports the comprehensibility of the project at once glance. An RSS feed enables users to be actively updated on website changes. The website was constantly updated and adjusted to reflect progress in the project.

Social media channels: LinkedIn and Twitter were filled with content on a regular basis, providing information about upcoming events, public deliverables and other news. 125 people connected to LinkedIn and Twitter gained more than 150 followers, each of them a potential multiplier.

BioConSepT whiteboard animation (<https://www.youtube.com/watch?v=lkXeRDUObYs>): To reach the general public a novel approach was designed in the form of a whiteboard animation. This short video demonstrates the advantages of second generation biomass and the multiple innovation steps involved until a final bioplastics product. So far it received more than 1300 views from all over the world on YouTube. The project YouTube channel also contains a trailer and an introduction for the Serious Game (www.youtube.com/user/BioConSepT).

The Serious Bio-Economy Game is an Edutainment tool developed in BioConSepT to learn the principles of the bio-based economy, which informs and educates the players, enabling them to negotiate and take informed decisions. Within the game, players discuss, collaborate, cooperate and compete with six stakeholders in one virtual world. They try to make the transformation from fossil based plastics towards bioplastics made from non-edible, second generation biomass. The game is an immersive experience and a unique take on using gaming technology to make players aware of topics involved in the transformation of the BioEconomy. To launch the game with one of the key target groups, policy makers, a gaming session took place before the EFIB 2015 in Brussels, with very enthusiastic reactions from the players. In December 2014 the BioConSepT Serious Game won the CommNet Impact award for dissemination towards policy makers.

Events and conferences:

The Exploitation event in Merseburg, Germany at the end of the project consisted of three elements: a workshop on demonstration including a visit to the Fraunhofer CBP pilot facility in Leuna and presentation of results not included in the piloting. Before the event a press talk was organized and the final consortium meeting was held afterwards. A total of 67 participants attended both from industry and academia, from within and outside the consortium. The program focused on the upscaling of FDCA production and epoxidation in demonstrations. A press release afterwards ensured Europe-wide coverage in relevant media. In addition to the training on piloting included in the exploitation event an ISPR (In-Situ Product Recovery) course was organized. This two-day training event for students, but also experienced researchers was hosted by VITO in Antwerp (Belgium). With 25 participants the course was fully booked. Due to the success of this training and the now available training material the project partners are considering to further execute the training course in a yearly event.

Highlights of participation in large conferences: In March 2013 BioConSepT participated in the Green Polymer Conference in Cologne with three presentations and a booth to introduce BioConSepT to approximately 100 valuable stakeholders from industry, science and policy makers. Two presentations at CommNets 2nd Bioeconomy Forum in Brussels in September 2013 focused on the economic feasibility of the project and led to an insightful discussion with business experts. At the International Bioeconomy Conference in Halle, Germany in May 2015 various project results, with a focus on upscaling were presented to more than 150 participants. Joining the EFIB 2015 as an exhibitor gave BioConSepT a major presence at Europe's most important conference on industrial biotechnology and the bioeconomy. Discussions at the booth helped to promote the final exploitation event three weeks later, BioConSepT results in general, but also exploitation of the Serious Game.

Advisory board meeting: academic and industry representatives were addressed in the advisory board meeting in September 2013 held in conjunction with the 4th consortium meeting in Novara, Italy. It led to valuable feedback on results and suggestions to ensure the future success of BioConSepT.

Publications

A range of dissemination material was prepared. This includes printed material like flyers and a poster, but also digitally spread 6-monthly newsletters and a factsheet. Three press releases marked important phases in the project: a press release at the launch of the project, a news release about the market report created by Weastra and a press release at the end of the project focusing on results and the exploitation event.

Scientific publications: peer reviewed scientific publications are the most important means to inform academia. Two were finished in 2014 by VITO, with several more in preparation. Several publications in industry journals contributed to the dissemination of BioConSepT and its results to industry experts.

Dissemination collaborations: were started with the FP7 project SYNPOL, also working on bioplastics, and Annex XI, an Industrial Energy Related Technologies and Systems (IETS) Implementing Agreement of the International Energy Agency (IEA). This project fosters cooperation in the bio-refinery sector. The collaboration agreements include mutual announcement of news items on the website and social media channels and promotion of events. With SYNPOL a joint publication in the Bioplastics Magazine was realized.

1.5. Website and contact details

1.5.1. Project website

A public website was launched which is running since June 2012, and will be kept operational until 31-12-2016. Although the website will not be updated actively, it contains a main overview of the project, its main deliverables and links to public reports. The website link is <http://www.bioconsept.eu>.

The public part enabled the reader to get a comprehensive overview of the project objectives and overall outline. Besides the news item, an event list, linked social media accounts, a tag cloud supported the comprehensibility of the project at one glance. Public deliverables, dissemination material, press/news releases were uploaded to the press corner.

The website was the central hub of communication within the consortium by means of an internal, login protected section.



Figure 21: Main page of BioConSepT website (www.bioconsept.eu) including links to amongst others the BioConSepT animation:

1.5.2. Contact details

The contact details of the coordinator and the individual partners are included in this section for further inquiries concerning the BioConSepT project.

Main contact details for BioConSepT: <mailto:bioconsept@tno.nl>

TNO - Netherlands Organization for Applied Scientific Research
Leeghwaterstraat 44, 2628 CA Delft, The Netherlands

Nadine Wennersbusch
Project Manager BioConSepT
nadine.wennersbusch@tno.nl
T: +31 (0) 88 866 6371

Carol Roa Engel
Scientific Coordination
carol.roaengel@tno.nl
T: +31 (0) 88 866 4192

The table below summarizes the main contacts of the project for each of the partners.

No.	Participant name		Type *	Country	Contact person
1	TNO	Netherlands Organization for Applied Scientific Research	RTO	NL	Carol Roa Engel (carol.roaengel@tno.nl) Nadine Wenersbusch (nadine.wenersbusch@tno.nl)
2	Vito	Vlaamse Instelling voor Technologisch Onderzoek N.V.	RTO	BE	Karolien Vanbroekhoven (karolien.vanbroekhoven@vito.be)
3	FhG	Fraunhofer-Gesellschaft zur Förderung der angewandten Forschung e.V.	RTO	DE	CBP: Katja Patzsch (katja.patzsch@igb.fraunhofer.de) IGB: Susanne Zibek (susanne.zibek@igb.fraunhofer.de) ICT: Kristian Kowollik (kristian.kowollik@ict.fraunhofer.de)
4	VTT	Teknologian tutkimuskeskus VTT Oy	RTO	FI	Tiina Nakari-Setälä (Tiina.Nakari-Setälä@vtt.fi) Laura Ruohonen (Laura.Ruohonen@vtt.fi)
5	TICON	T+I Consulting	SME	DE	Rainer Busch (office@rbusch.de)
8	Leitat	Acondicionamiento tarrasense asociación	RTO	ES	Raquel de Sousa (rdesousa@leitat.org)
9	Novamont	Novamont S.p.A.	IND	IT	Cecilia Giardi (Cecilia.Giardi@novamont.com)
10	Poyry	Pöyry Management Consulting Oy	IND	FI	Jesse Kautto (jesse.kautto@poyry.com)
11	Proviron	Proviron Holding NV	IND	BE	Jelle Cornelus (jelle.cornelus@proviron.com)
12	Rhodia	Rhodia Operations (Solvay)	IND	FR	Thierry Vidal (thierry.vidal@solvay.com)
13	Clariant	Clariant Produkte (Deutschland) GmbH	IND	DE	Georg Schirmmacher (Georg.Schirmmacher@clariant.com)
14	Taminco	Taminco bvba	IND	BE	Kristof Moonen (kristofmoonen@eastman.com)
15	Applikon	Applikon Biotechnology B.V.	SME	NL	Gerben Brans (g.brans@applikon-biotechnology.com)
18	CLEA	CLEA Technologies B.V.	SME	NL	Menno Sorgedrager (sorgedrager@clea.nl)
19	DE	Designer Energy Ltd.	SME	IL	Alon Karpol (alon@designerenergy.net)
21	EB	Eucodis Bioscience GmbH	SME	AT	Jan Modregger (modregger@eucodis.com)
22	GTVT	GTVT s.r.o.	SME	SI	Natasa Siskova (natasa.siskova@gmail.com)
24	RTDS	RTD Services	SME	AT	Stephen Webb (webb@rtds-group.com)
25	Sunilei	Sunilei Tecnología Solar SA	SME	ES	Sergio Ibáñez (projects@sunilei.es)
26	Tygron	Tygron Serious Gaming B.V.	SME	NL	Hansje Hooghiemstra (hansje@tygron.com)
27	Weastra	Weastra s.r.o.	SME	SI	Viera Liebe (viera@gfah.eu)
28	Zena	Zena s.r.o.	SME	CZ	Mirko Dohnal (dohnal@zena-membranes.cz)
29	Fluor	Fluor B.V.	IND	NL	Jelle Ernst Oude Lenferink (Jelle.Ernst.Oude.Lenferink@fluor.com)
30	Ingenza	Ingenza Ltd.	SME	UK	Alison Arnold (alison.arnold@ingenza.com)
31	Lucite	Lucite International UK Ltd.	IND	UK	Graham R. Eastham (graham.eastham@lucite.com)
32	BCZ	Biochemize SL	SME	ES	Jaume Mir Martinez (jmir@biochemize.com)
33	AVA	AVA Biochem BSL AG	SME	CH	Gilbert Anderer (gilbert.anderer@ava-biochem.com)
34	ADM Research	ADM Research GmbH	IND	DE	Phil Hogan (phil.hogan@adm.com)
35	Evonik	Evonik Performance Materials GmbH	IND	DE	Michael Graß (michael1.grass@evonik.com) Florian Boeck (florian.boeck@evonik.com)